

SURLAST

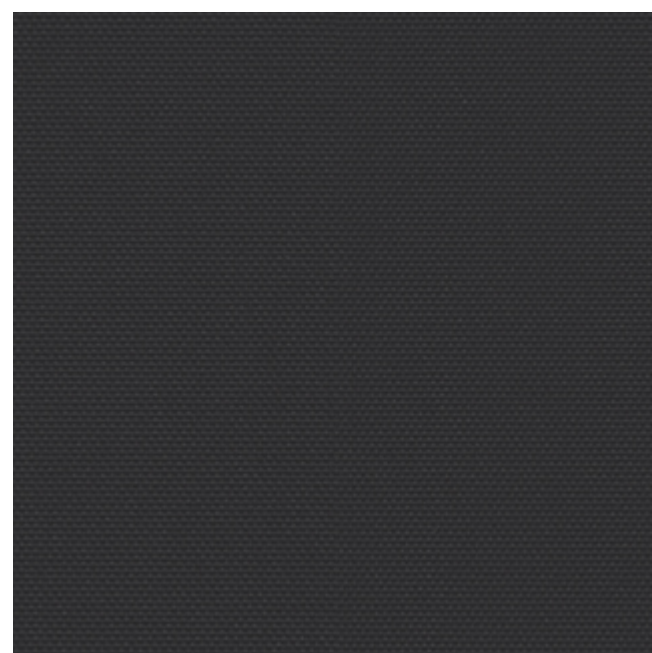

SURLAST



Black
SUR 3854 152



Admiral Navy
SUR 3866 152



Light Grey
SUR 3862 152



Sand
SUR 3853 152



WATER
RESISTANCE
Imperméabilité



COMPACT
STORAGE
Encombrement réduit



THINNESS
Finesse

● Recommended
Recommandé

● Possible

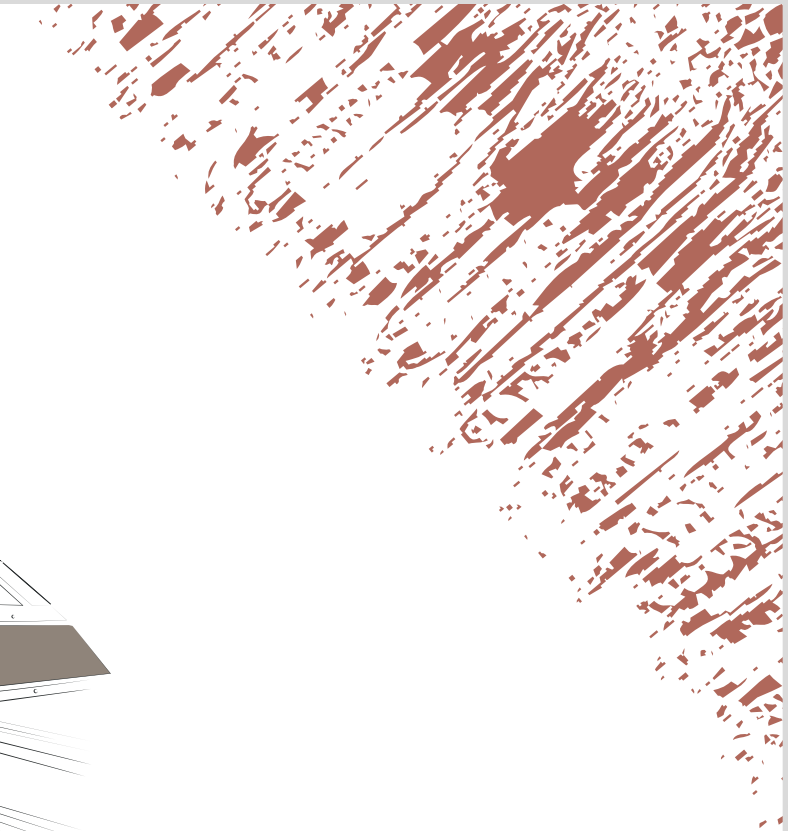
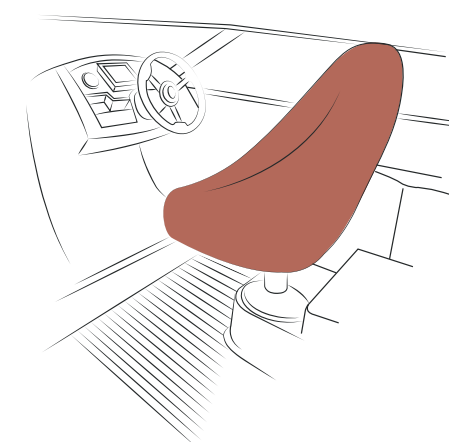
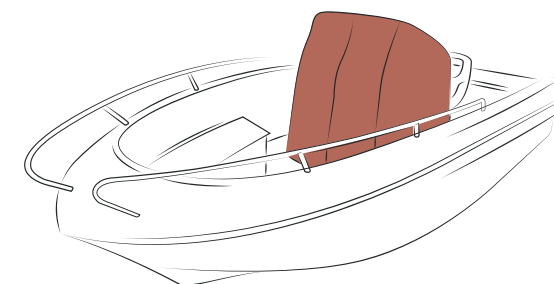
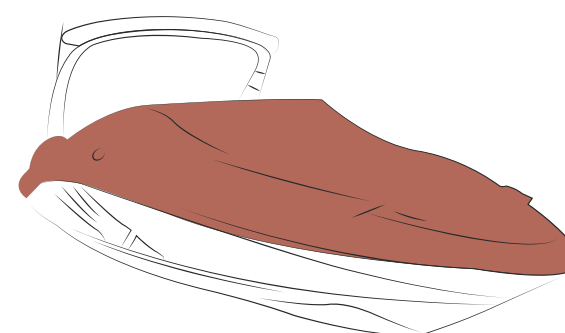
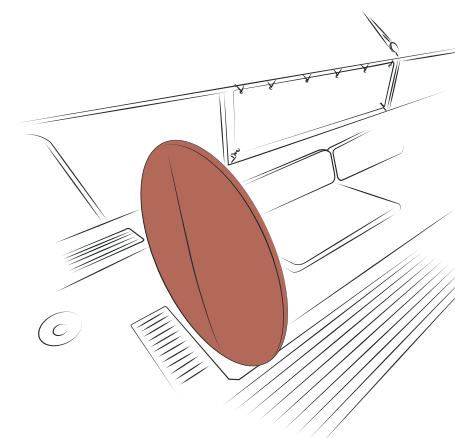
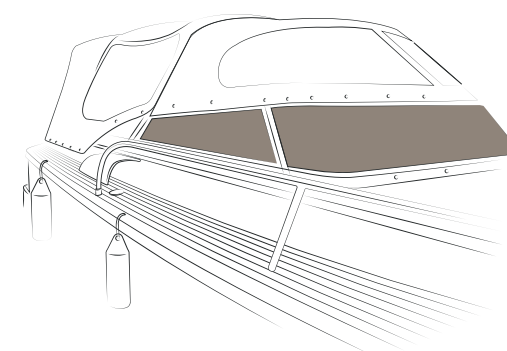



OVERALL CHARACTERISTICS / CARACTÉRISTIQUES GÉNÉRALES

Composition	100% solution dyed polyester 100% polyester teinté dans la masse
Finish Finition	PU coating on one side Enduction polyuréthane sur une face
Weight / Poids - ISO 3801	240 g/m ²
Width / Laize - EN 1773	152,5 cm

FABRIC STRENGTH / RÉSISTANCE DU TISSU

Tensile strength - ISO 13934-1 Résistance rupture - ISO 13934-1	Warp 217 daN - Weft 152 daN Chaîne 217 daN - Trame 152 daN
Tear strength - ISO 13937-1 Résistance déchirure - ISO 13937-1	Warp 9,9 daN - Weft 8,7 daN Chaîne 9,9 daN - Trame 8,7 daN
Schmerber - ISO 811	850 mm

COLOUR RESISTANCE / RÉSISTANCE DES COULEURS

Colour fastness weather condition Solidité coloris intempéries - ISO 105 B04	4/5
---------------------------------------------------------------------------------	-----

USE / UTILISATION

Roll length / Longueur de coupe	90 m
---------------------------------	------

Recommended use Utilisation recommandée	Console cover, external windshield cover, winter cover, wheel & winch cover, fitted cover for seats Housse de console, housse de pare-brise, housse d'hivernage, housse de barre à roue, housse de winch, housse de sièges
--------------------------------------------	-------------------------------------------------------------------------------------------------------------------------------------------------------------------------------------------------------------------------------------------

Guarantee / Garantie	3 years* / 3 ans**
----------------------	--------------------

